

# AG2 Series Insert Manual



For complete installation instructions, see the Tube Heater General Manual that accompanies this Series Insert Manual.

The AG2 Series Infra-Red Tube Heater is a positive pressure, two-stage radiant heater system. This insert manual is a supplement to the Tube Heater General Manual and provides specific information related to the AG2 Series model. All persons involved with the installation, operation and maintenance of the heater system must read and understand the information in this insert manual and the accompanying Tube Heater General Manual.

## ⚠ WARNING



Improper installation, adjustment, alteration, service or maintenance can cause property damage, injury or death. Read the installation, operation and maintenance instructions thoroughly before installing or servicing this equipment.

This heater must be installed and serviced by trained gas installation and service personnel only. Failure to comply could result in personal injury, asphyxiation, death, fire or property damage.



In locations used for the storage of combustible materials, signs must be posted to specify the maximum permissible stacking height to maintain the required clearances from the heater to the combustibles. Signs must either be posted adjacent to the heater thermostats or in the absence of such thermostats, in a conspicuous location.



**Not for residential use!** Do not use this heater in the home, sleeping quarters, attached garages, etc. Installation of a commercial tube heater system in residential indoor spaces may result in property damage, serious injury, asphyxiation or death.

## For Your Safety

### If you smell gas:

- Do not try to light any appliance.
- Do not touch any electrical switch.
- Do not use any phone in your building.
- Immediately call your gas supplier from a neighbor's phone.
- Follow the gas supplier's instructions.
- If you cannot reach your gas supplier, call the fire department.

**Keep these instructions for future reference.**

# Contents

---

- 1.0 Safety . . . . . 3**
  - Safety Labels and Locations . . . . . 3
  - Clearance to Combustibles . . . . . 4
- 2.0 Installation . . . . . 6**
  - Combustion Air . . . . . 6
  - Electrical Requirements . . . . . 7
  - Wiring . . . . . 7
  - Specifications . . . . . 10
  - Tube Installation Sequence . . . . . 11
- 3.0 Operation . . . . . 12**
  - Sequence of Operation . . . . . 12
  - Thermostat . . . . . 12
  - Diagnostics . . . . . 13
- 4.0 Troubleshooting Guide . . . . . 14**
- 5.0 Parts . . . . . 18**
  - Components . . . . . 18
  - Parts List . . . . . 18
  - Kit Contents Check List . . . . . 20
  - Approvals . . . . . 20
  - Limited Warranty . . . . . 20

**NOTE:** See page 10 for a list of available models and specifications.

# 1.0 Safety



Read and understand all safety information and warnings in this insert manual and the Tube Heater General Manual before installation, operation and maintenance of the radiant tube heater system.

## Safety Labels and Their Locations

Product safety signs or labels should be replaced by the product user when they no longer are legible. Contact either your local distributor or the product manufacturer for obtaining replacement signs or labels.

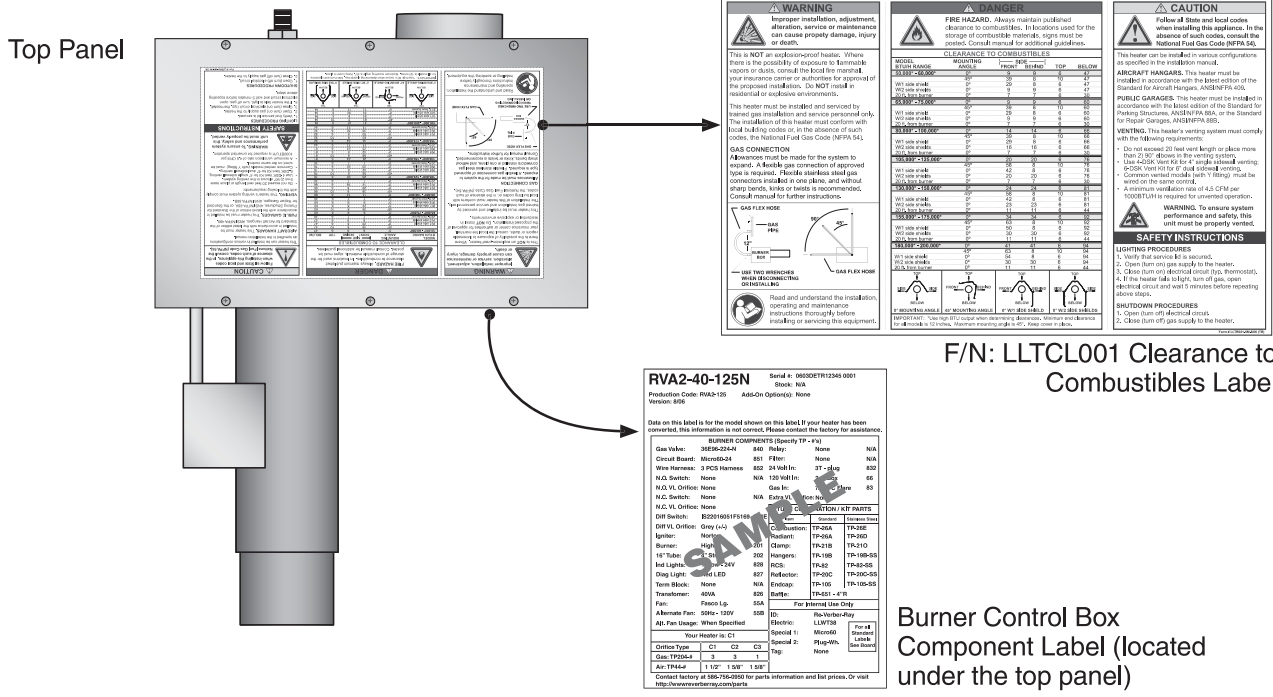
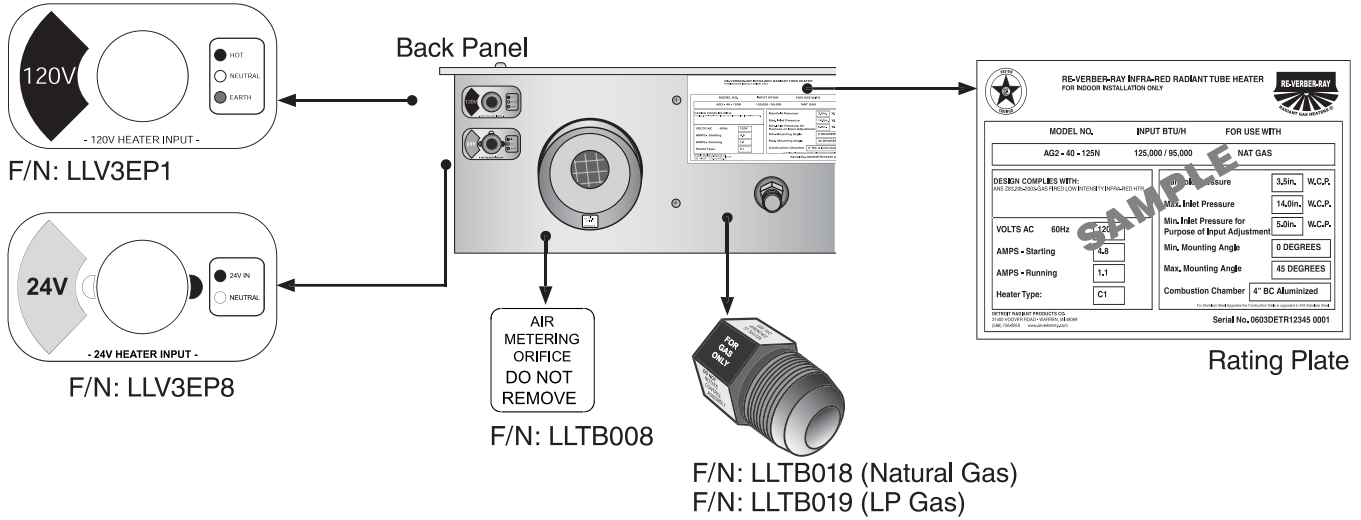

F/N: LLTB007(2)

LED CODE	FAULT STATUS	FAULT CODE DELAY
Initial flash on power up, then steady off	Normal operation	Immediate
Steady on	Module failure / Internal fault	Immediate
1 flash	Ignition failure	30-32 minutes
2 or 3 flashes	APS - Note: fan / intake / exhaust	10-12 minutes
4 flashes	Solenoid valve fault / Leaky valve / Flame amplifier fault	Immediate
No flash on 117V start up	Transformer fault	Immediate



F/N: LLDR003  
(This label is located on models with a relay board installed only).

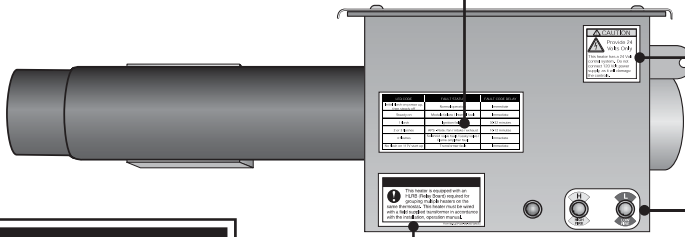

**Left Panel**  
(Fan Compartment)

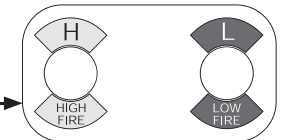

F/N: LLV2EP9

**!** This heater is equipped with an HLRB (Relay Board) required for grouping multiple heaters on the same thermostat. This heater must be wired with a field supplied transformer in accordance with the installation, operation manual.

F/N: LLTP031 (This label is located on models with a relay board installed only.)

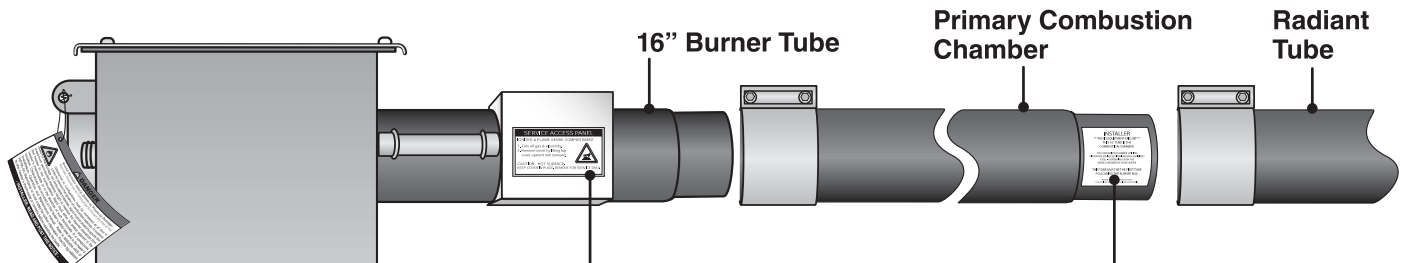

**Right Panel**  
(Valve Compartment)

**!**  
Avoid Serious Injury, Death or Property Damage.  
Maintain Clearances to Combustible to Prevent the Risk of Fire.

**- INSTALLER: READ AND POST THIS NOTICE -**

F/N: LL01 - Clearance Safety Tag  
(Affix adjacent to heater's thermostat)

**SERVICE ACCESS PANEL**  
IGNITER & FLAME SENSE COMPARTMENT

1. Turn off gas & electricity.
2. Remove cover by lifting top cover upward and outward.

**CAUTION: HOT SURFACE.**  
KEEP COVER IN PLACE. REMOVE FOR SERVICE ONLY.

F/N: LLTB026

**! INSTALLER**

**AVOID EQUIPMENT FAILURE**

**THIS 10 FT. TUBE IS THE COMBUSTION CHAMBER.**

The combustion chamber utilizes either 409 stainless, titanium alloy or aluminized steel - depending on the model number of your heater.

**THIS TUBE MUST BE THE FIRST TUBE FOLLOWING THE BURNER CONTROL BOX.**

Rotate the tube's welded seam to bottom.  
Consult the manual(s) for further details.

F/N: LLTB004 (orange)

## Clearance to Combustibles

### ⚠ WARNING



Placement of explosive objects, flammable objects, liquids and vapors close to the heater may result in explosion, fire, property damage, serious injury or death. Do not store or use explosive objects, liquids or vapor in the vicinity of the heater.

Clearance to combustibles is defined as the minimum distance that must exist between the tube surface, or reflector, and any combustible items (see Figure 1.1). It also pertains to the distance that must be maintained from moving objects around the tube heater. When installing the tube heater system, clearances to combustibles for the Series tube heater and configuration must be maintained.

Chart 1.1 • Clearance to Combustibles in Inches (see Figure 1.1 for Mounting Angles)

Model Number	Mounting Angle*	Sides		Top**	Below
		Front	Behind		
AG2 (20, 30, 40) - (65, 75) [N, P] with 1 side shield with 2 side shields 20 ft. from burner	0°	9	9	6	60
	45°	39	8	10	60
	0°	29	8	6	60
	0°	9	9	6	60
	0°	7	7	6	30
AG2 (30, 40, 50) - 100 [N, P] with 1 side shield with 2 side shields 20 ft. from burner	0°	14	14	6	66
	45°	39	8	10	66
	0°	29	8	6	66
	0°	16	16	6	66
	0°	7	7	6	30
AG2 (40, 50) - 125 [N, P] with 1 side shield with 2 side shields 20 ft. from burner	0°	20	20	6	76
	45°	58	8	10	76
	0°	42	8	6	76
	0°	20	20	6	76
	0°	7	7	6	30
AG2 (40, 50, 60) - 150 [N, P] with 1 side shield with 2 side shields 20 ft. from burner	0°	24	24	6	81
	45°	58	8	10	81
	0°	42	8	6	81
	0°	23	23	6	81
	0°	11	11	6	44

\* Heaters mounted on an angle between 0° to 45° must maintain clearances posted for 0° or 45°; whichever is greater.

\*\* Maintain a 10 in. (0° mounting angle) or 12 in (1-45° mounting angle) clearance from ceilings constructed of tri-ply plastic or plastic fogger lines.

Figure 1.1 • Mounting Angles

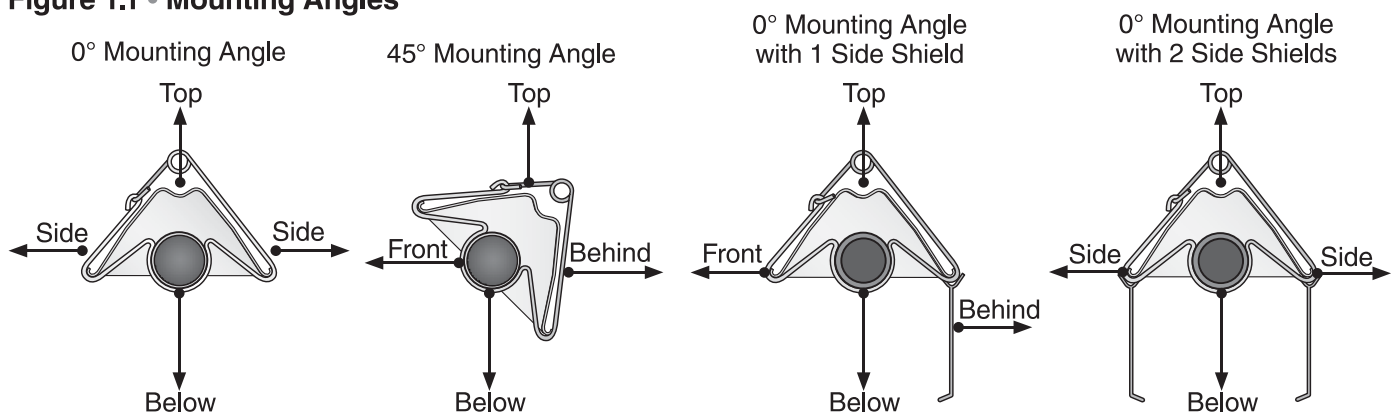

## 2.0 Installation

### ⚠ WARNING



Improper installation, adjustment, alteration, service or maintenance can cause property damage, serious injury or death. Read and understand the installation, operating and maintenance instructions thoroughly before installing or servicing this equipment. Only trained, qualified gas installation and service personnel may install or service this equipment.

**Not for residential use!** Do not use this heater in the home, sleeping quarters, attached garages, etc. Installation of a commercial tube heater system in residential indoor spaces may result in property damage, serious injury or death.

Instructions for the following are detailed in the Tube Heater General Manual:

- Design considerations
- Hanger suspension and placement (**Note:** Placement for poultry facilities on page 9).
- Tube layout and assembly
- Burner control box suspension
- Reflectors (and accessories)
- Venting and combustion air intake
- Gas requirements
- Baffle assembly

**NOTE:** Electronic versions of all manuals are available at [www.detroitradiant.com](http://www.detroitradiant.com).

### Combustion Air

The combustion air intake collar is also a factory preset air orifice. Non-contaminated air for combustion **must** be ducted to the heater in all agricultural applications. **Do not** take combustion air from pressurized attic spaces, with the exception of broiler houses.

Locate the air intake away from any steam source. Use caution when locating air intake above curtain walls, as they can leak. When curtain walls are present, use 4-inch light gauge PVC air intake material from curtain sidewall to the heater; do not exceed 25 feet. With an elbow, drop intake one foot below the top of the curtain wall. Cap intake with a 1/4-inch birdscreen. Figure 2.1.

**Figure 2.1 • Combustion Air Intake (Broiler House)**

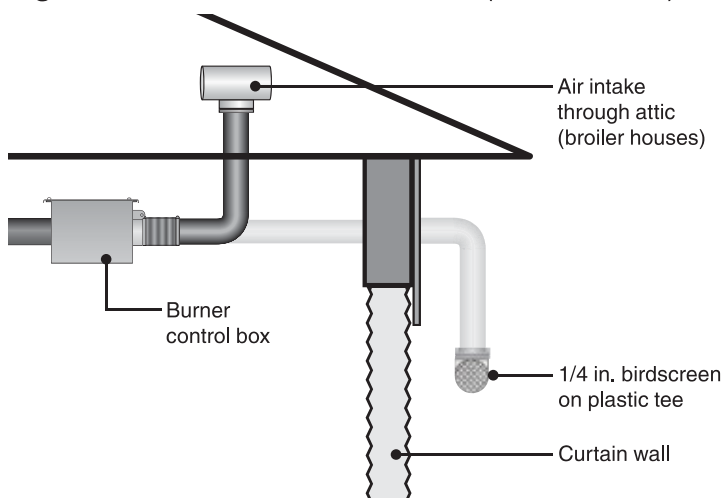

## Electrical Requirements

Connecting the thermostat with a voltage other than 24V may damage the heater. The AG2 Series requires a 24V connection to the thermostat. This is supplied by an external transformer (field supplied). See below.

- 120 Volt - 60 Hz GRD, 3-wire.
- 24V control connection.
- Starting current 4.8 amps
- Running current 1.1 amps

The AG2 Series is equipped standard with an internal relay board. 24 volts must be supplied to each heater’s yellow control cord. 120 volts is supplied to the heater’s black cord; observe polarity.

Confirm proper two-stage electrical wiring by cycling heater between stages. Confirm proper operation of high fire, low fire and off cycles.

## Wiring

### ⚠ WARNING



#### Electric Shock

Field wiring to the tube heater must be connected and grounded according to the guidelines in the Tube Heater General Manual and Series Insert Manual and in accordance with national, state, provincial and local codes. In the United States refer to the most current revisions to the ANSI/NFPA 70 Standard and in Canada refer to the most current revisions to the CSA C22.1 Part I Standard.

Figure 2.2 • Field Wiring Diagrams

#### A. Multiple Heaters, Single Control. With Relay Board

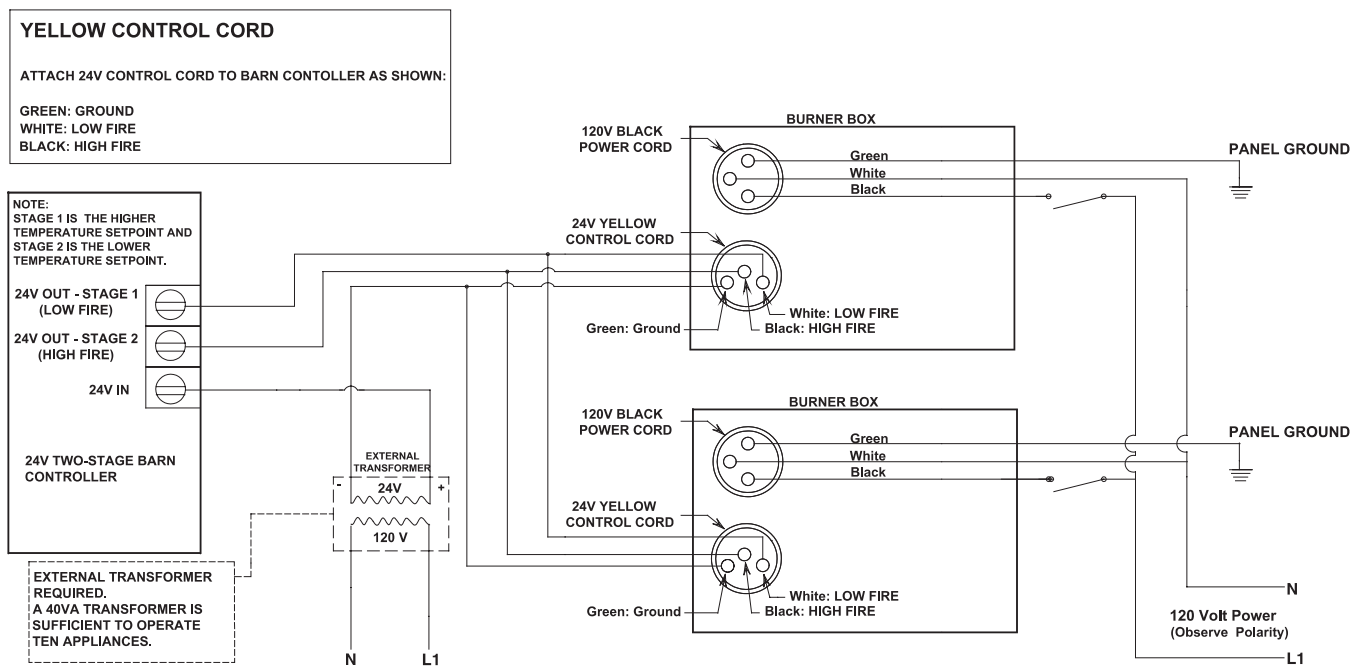

**Before field wiring this appliance - Check existing wiring; replace if necessary.**

**Note:** If any of the original wire as supplied with the appliance must be replaced, it must be replaced with wiring material having a temperature rating of at least 105° C.

**Figure 2.3 • Internal Wiring Diagrams**

**A. Micro 60U-24 Ladder Diagram**

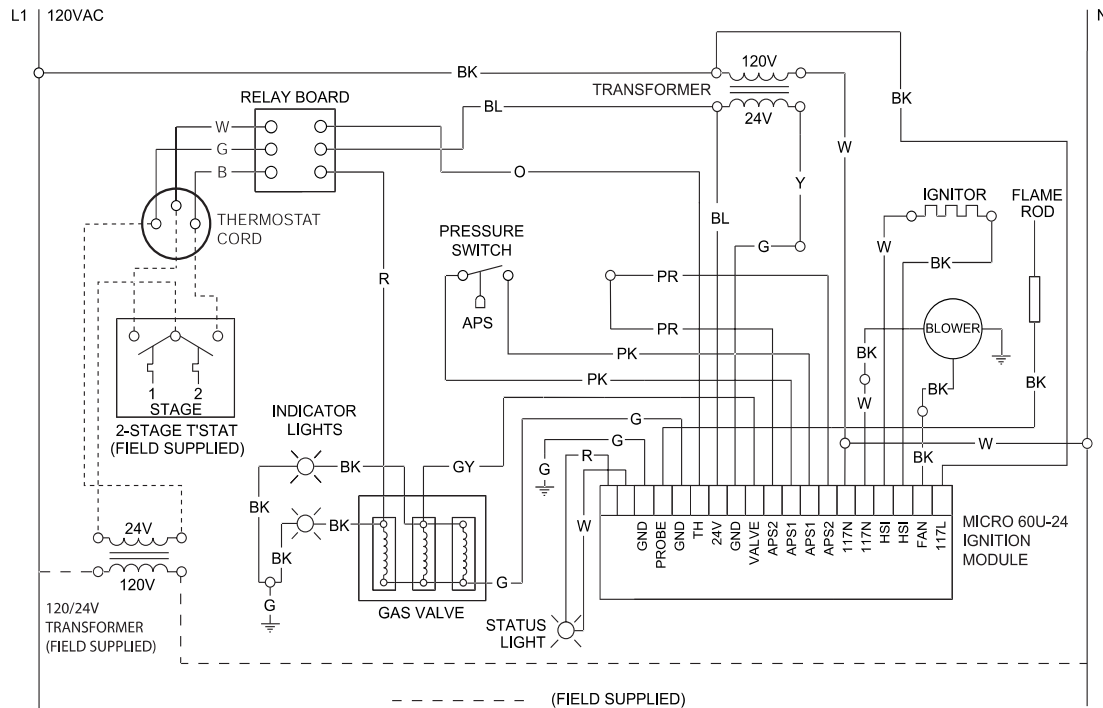

**B. Micro 60U-24 Block Diagram**

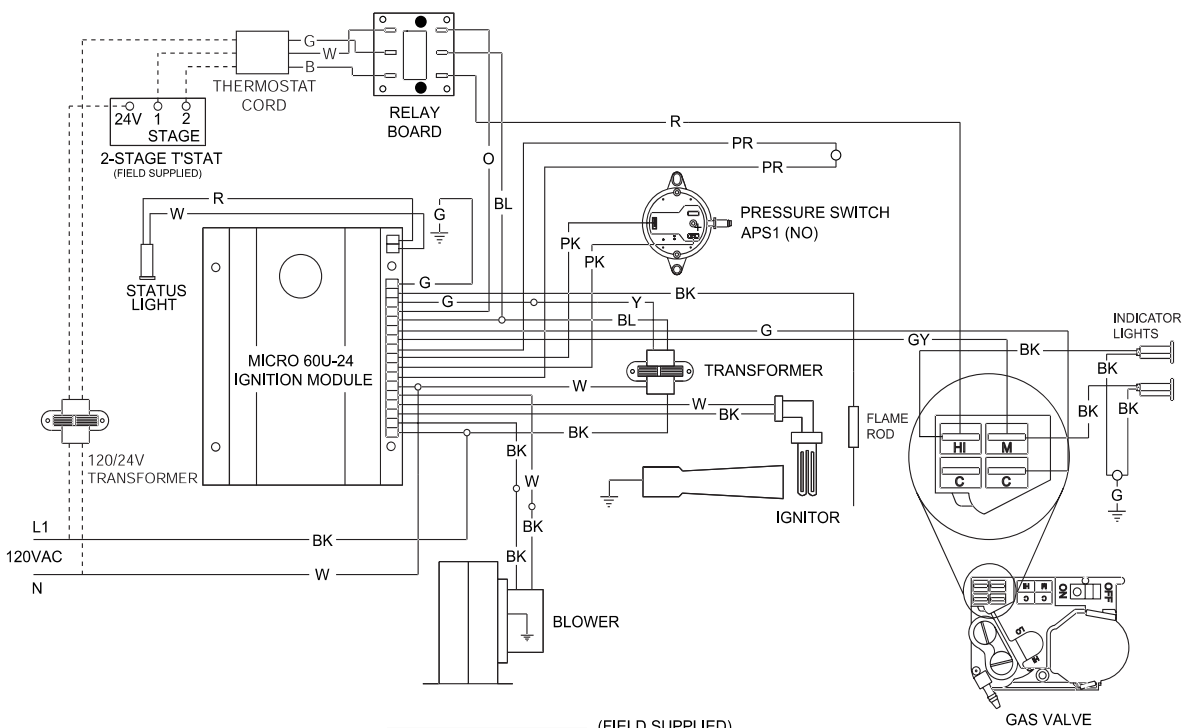
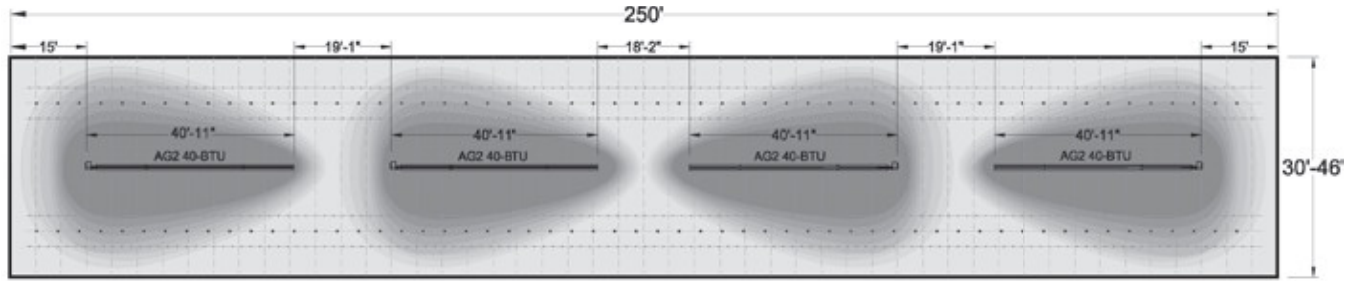



Figure 2.4 • Sample Brooder Installation Diagrams

A. Center House Installation



**NOTE:** Utilize elongated hangers (TP-19E) on houses 60 feet or more with center house mounting to allow for a wider throw pattern.

B. Side Wall Installation

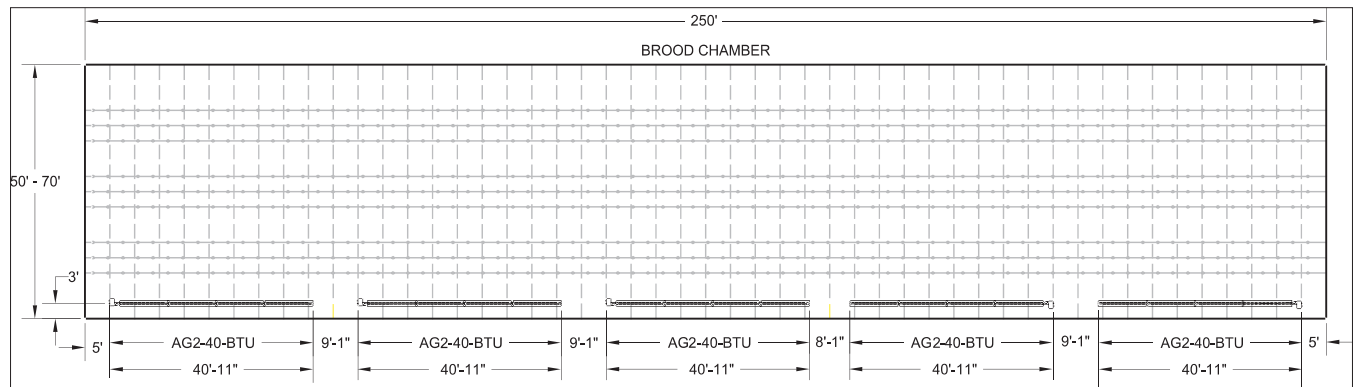

**NOTE:** Mount Reflector at a 45° angle toward center. **NOTE:** Standard hangers (TP-19B) are used when sidewall mounting. Elongated hangers (TP-19E) are not to be used.

C. 30 ft., 40 ft. and 50 ft. Tube Brooder Installation (houses with 4 ft. and 5 ft. on center truss locations).

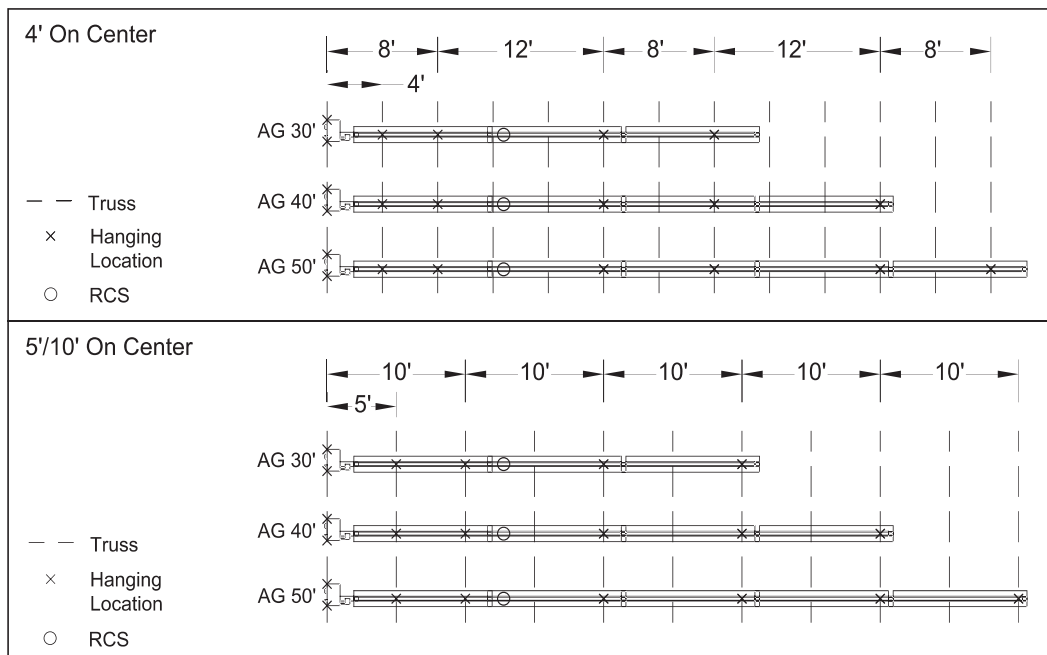

## Specifications

Chart 2.1 • Specifications

Model Number	Gas Type (select one)	BTU/H (High Fire)	BTU/H (Low Fire)	Straight Length	U-Tube Length	Standard Weight (lbs.)	Recommended Mounting Height Above Animals	Combustion Chamber (uncoated)	Radiant Emitter Tube(s) (uncoated)^	Radiant Surface Area (sq. ft.)	36" Baffle Sections	Optional Alum-AO Quantity
AG2-20-65	N or LP	65,000	50,000	21'-7"	13'-0"	120	6' to 9'	Alum	HRT	20.2	5	1
AG2-20-75	N or LP	75,000	50,000	21'-7"	13'-0"	120	7' to 10'	Alum	HRT	20.2	5	1
AG2-30-65	N or LP	65,000	50,000	31'-3"	*17'-8"	160	6' to 9'	Alum	HRT	30.4	5	2
AG2-30-75	N or LP	75,000	50,000	31'-3"	*17'-8"	160	7' to 10'	Alum	HRT	30.4	5	2
AG2-30-100	N or LP	100,000	65,000	31'-3"	*17'-8"	160	8' to 14'	Alum	HRT	30.4	6	2
AG2-40-65	N or LP	65,000	50,000	40'-11"	22'-8"	190	6' to 9'	Alum	HRT	40.5	5	3
AG2-40-75	N or LP	75,000	50,000	40'-11"	22'-8"	190	7' to 10'	Alum	HRT	40.5	5	3
AG2-40-100	N or LP	100,000	65,000	40'-11"	22'-8"	190	7' to 11'	Alum	HRT	40.5	5	3
AG2-40-125	N or LP	125,000	95,000	40'-11"	22'-8"	190	9' to 14'	Alum	HRT	40.5	5	3
AG2-40-150	N or LP	150,000	100,000	40'-11"	22'-8"	190	10' to 14'	Ti-AL	HRT	40.5	5	3
AG2-50-100	N or LP	100,000	65,000	50'-7"	*27'-4"	235	8' to 11'	Alum	HRT	50.6	5	4
AG2-50-125	N or LP	125,000	95,000	50'-7"	*27'-4"	235	9' to 14'	Alum	HRT	50.6	5	4
AG2-50-150	N or LP	150,000	100,000	50'-7"	*27'-4"	235	10' to 14'	Ti-AL	HRT	50.6	5	4
AG2-60-150	N or LP	150,000	100,000	60'-3"	32'-4"	265	10' to 14'	Ti-AL	HRT	60.7	5	5

\* Model requires 5EA-SUB accessory package when installing in a 'U' configuration (P/N: TF1B).

^ ALUM-AO: Upgrade hot-rolled steel (HRT) radiant tubes to 16 gauge, black coated, aluminized steel for maximum efficiency and longevity. **NOTE:** This option is highly recommended in contaminated or moisture laden environments (i.e. poultry applications). See Chart 2.1 for quantity needed per heater.





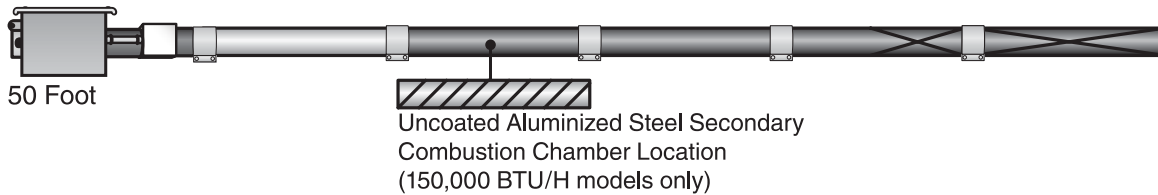
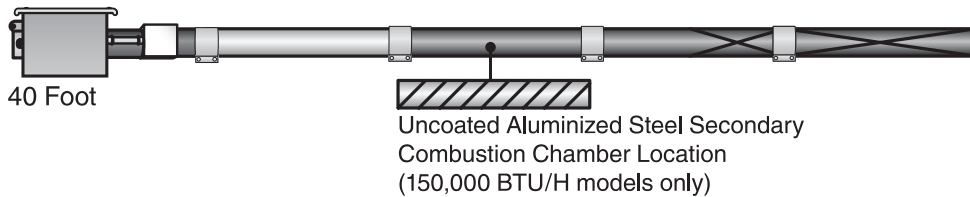
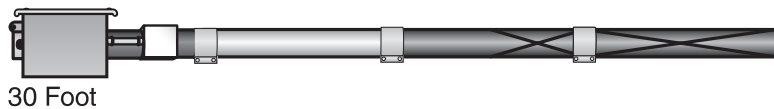
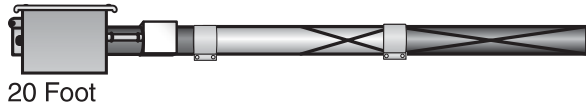

AGAO-SS: Upgrade burner control box from coated steel to 304 Series stainless steel.

## Tube Installation Sequence

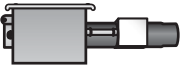
**Figure 2.5 • Tube Installation Sequence**

**Important!** The combustion chamber & radiant tube sections must be installed in the following order.



Key			
	Burner Control Box with 16" Burner Tube		Hot-Rolled Steel Radiant Emitter Tube or ALUM-AO
	Uncoated Steel Primary Combustion Chamber		Tube Clamp
	Uncoated Aluminized Steel Secondary Combustion Chamber (150,000 BTU/H models only)		Baffle Location

**NOTE:** Refer to the Tube Heater General Manual, Chart 3.6 (page 22) for secured reflector joints.

# 3.0 Operation

---

## ⚠ WARNING



This heater must be installed and serviced by trained gas installation and service personnel only.

Do not bypass any safety features or the heater's built in safety mechanisms will be compromised.

---

**Note:** Reference the Tube Heater General Manual for installation requirements.

### Sequence of Operation

---

**Standby:** The MICRO 60U-24 CONTROL continually checks for internal faults, circuit integrity and relay contact positioning.

**Starting Circuit:** Upon a call for heat, the control verifies that the differential switch is in the proper position (open). The control energizes the fan. Once operational static pressure is achieved, the differential switch will close initiating the ignition sequence. The glo-bar is powered and the gas valve opens after 45 seconds. If the flame is not sensed, the heater will attempt to re-ignite for a total of three (3) trials for ignition before proceeding to soft lockout.

**Single Stage Running Circuit:** After ignition, the flame rod monitors burner flame. If sense of flame is lost, the control closes the gas valve within one second and a new trial sequence (identical to the starting sequence) is initiated. If flame sense is not established within 8.5 seconds, the heater will attempt two (2) additional ignition sequences before proceeding to soft lockout. The control can be reset by briefly interrupting the power source.

**Two Stage Running Circuit:** The second stage on the gas valve is powered directly from the second stage of the thermostat. In order for two stage to flow to a higher output, single stage must be energized as well. The thermostat determines which stage to maintain for the desired temperature.

**Shut Down:** When the thermostat is satisfied, the fan will enter a two (2) minute post-purge cycle. Then go to diagnostics; soft & hard lockout.

### Thermostat

---

**Note:** Different thermostats operate according to their particular features. Refer to thermostat specifications for details.

AG2 Series heaters require a 24V, two-stage thermostat to operate. The burner control box is equipped with a 36" yellow 24V control wire. Do not supply 120V to the 24V connection.

**Theoretical Example:** The thermostat is set to 65° F. The thermostat's preset differential for high fire mode is 3° F.

When the temperature drops below the setpoint of the thermostat (65° F), low fire will activate. If the temperature continues to drop below the setpoint by another 3° F (62° F), high fire will activate bringing the temperature back up to the thermostat's setpoint quickly.

## Diagnostics

### Lockout:

The controls will automatically lockout the heater system when an external or system fault occurs. There are two types of lockout:

**Soft Lockout:** The heater will attempt to light three times. In the event of a failed attempt to light, (gas pressure, valve, no flame sense etc.), the heater will enter a soft lockout period for 30 minutes and then attempt to light three more times before entering Hard Lockout mode.

**Hard Lockout:** If proof of flame is not established, a component failure occurs or blockages are evident, the heater will enter hard lockout. If lockout occurs, the control can be reset by briefly interrupting the power source. Refer to Chart 3.1 below for a description of LED codes.

**Figure 3.1 • LED Operation Indicator Lights**

**Note:** Hard lockout LED CODE will appear upon completion of the soft lockout sequence of operation.

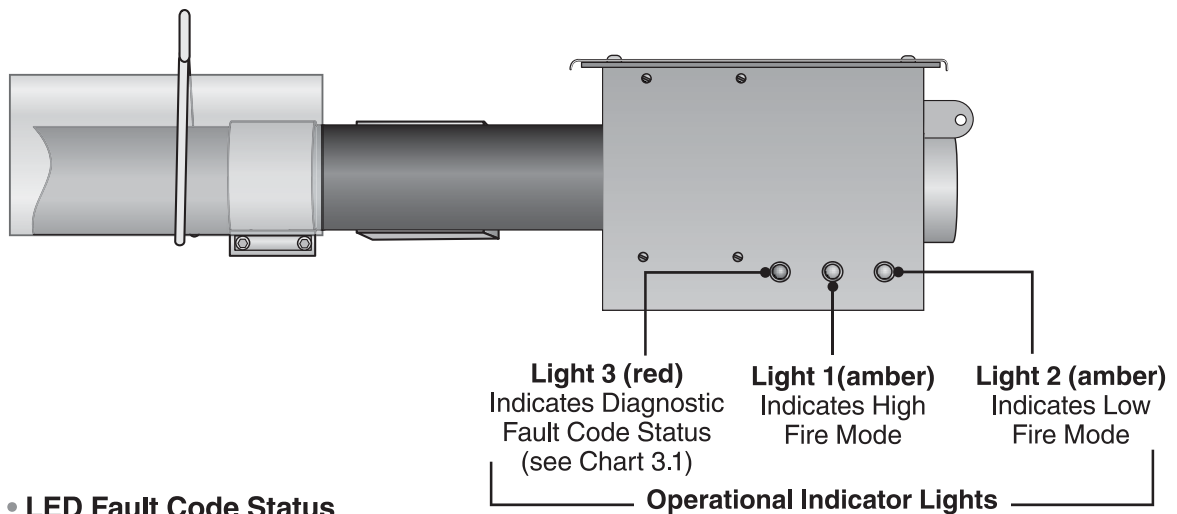
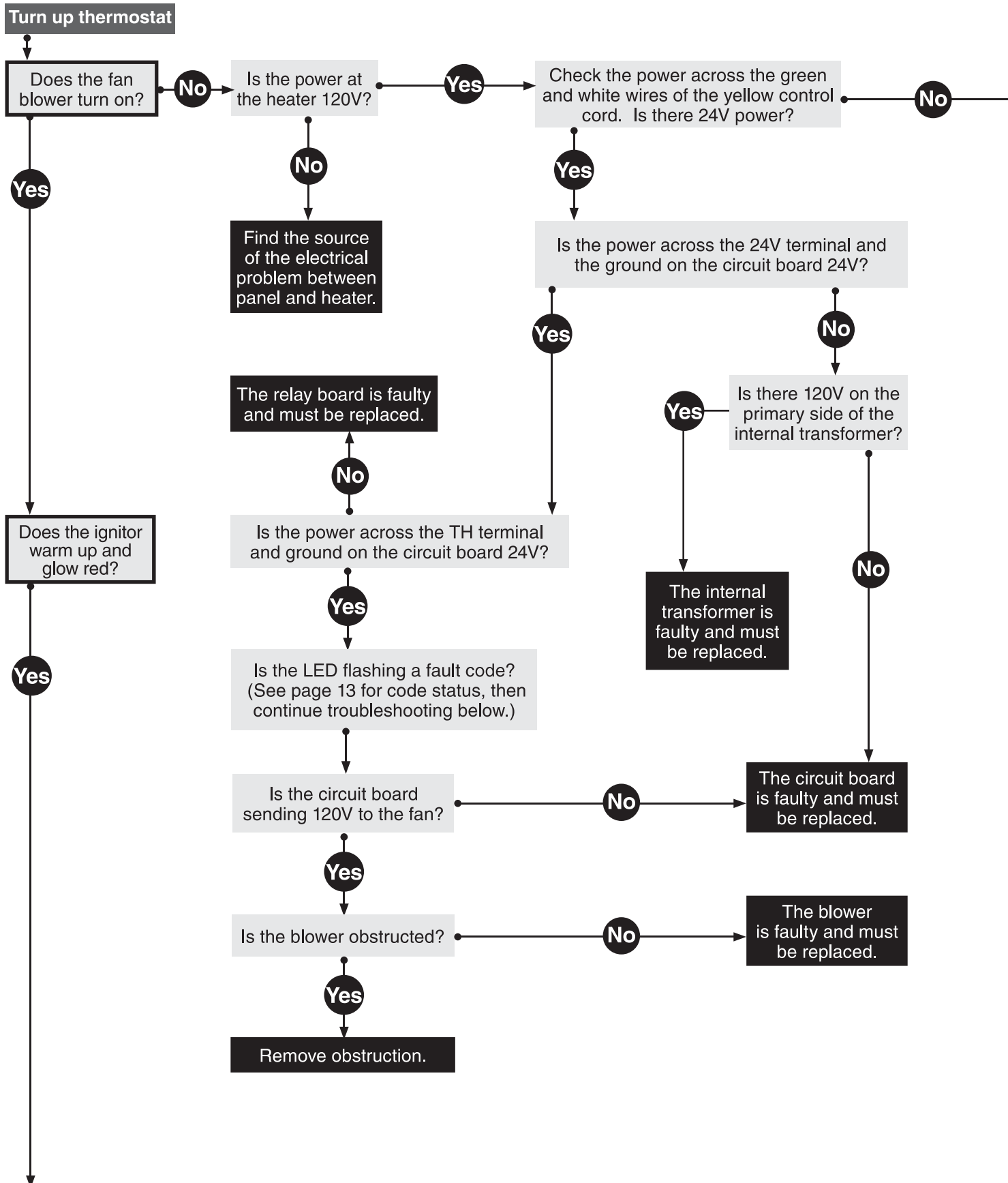

**Chart 3.1 • LED Fault Code Status**

LED Code	Fault Status	Fault Code Delay*
Initial flash on power up, then steady off	No fault, normal operation	No Delay
Steady ON	Module failure / Internal fault	No Delay
1 flash	Ignition failure	30 – 32 minutes
2 or 3 flashes	APS (Air Proving Switch) (Fan / Intake / Exhaust)	10 – 12 minutes
4 flashes	Solenoid valve fault Leaky valve Flame amplifier fault	No Delay
No flash on 117V startup	Transformer fault	No Delay

\*Some LED codes have a time delay before the LED will flash.

# 4.0 Troubleshooting Guide





Continued on page 16.

**NOTICE**

Bypassing any switch is intended for testing purposes only. Do not leave switch bypassed during normal operation or the heater's built-in safety mechanisms will be compromised.

**Key**

-  Start Question
-  Process Question
-  Corrective Action

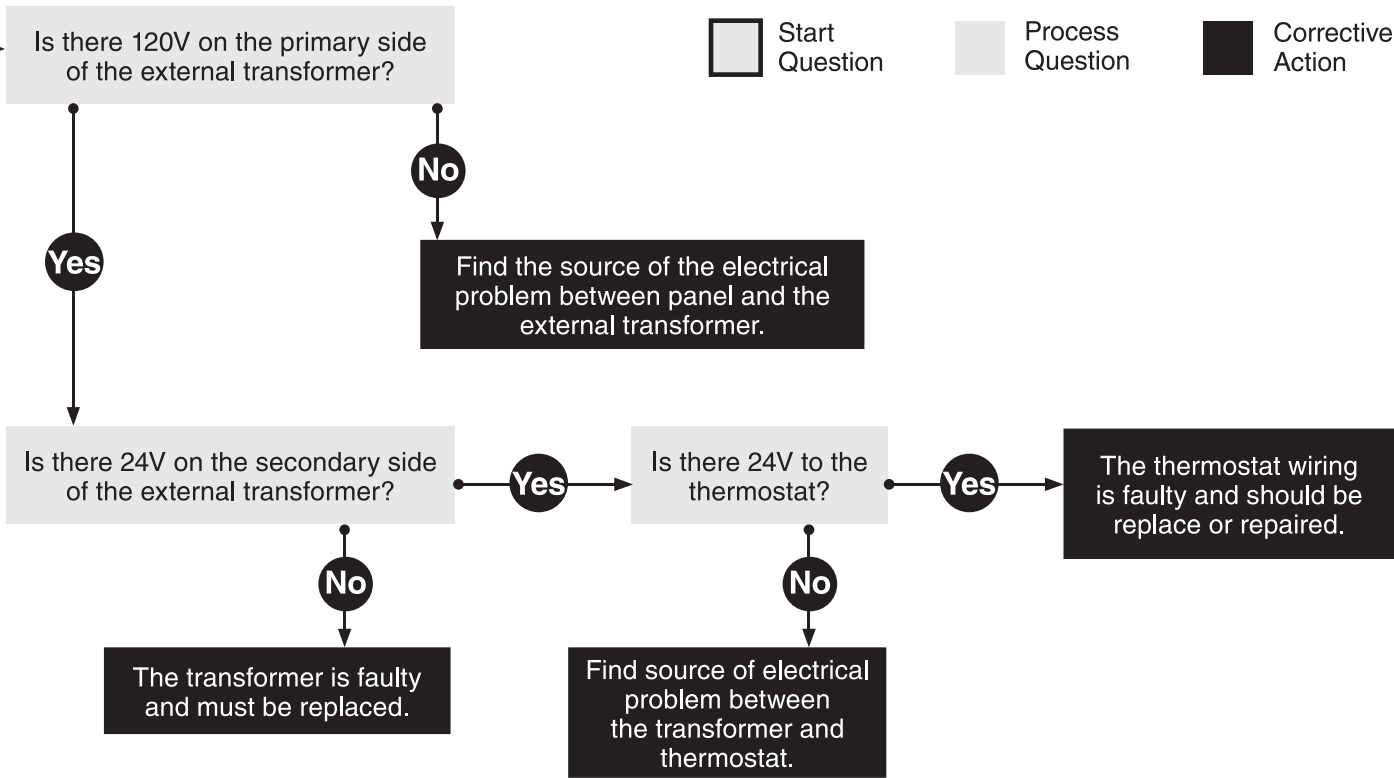

Continued from page 14.

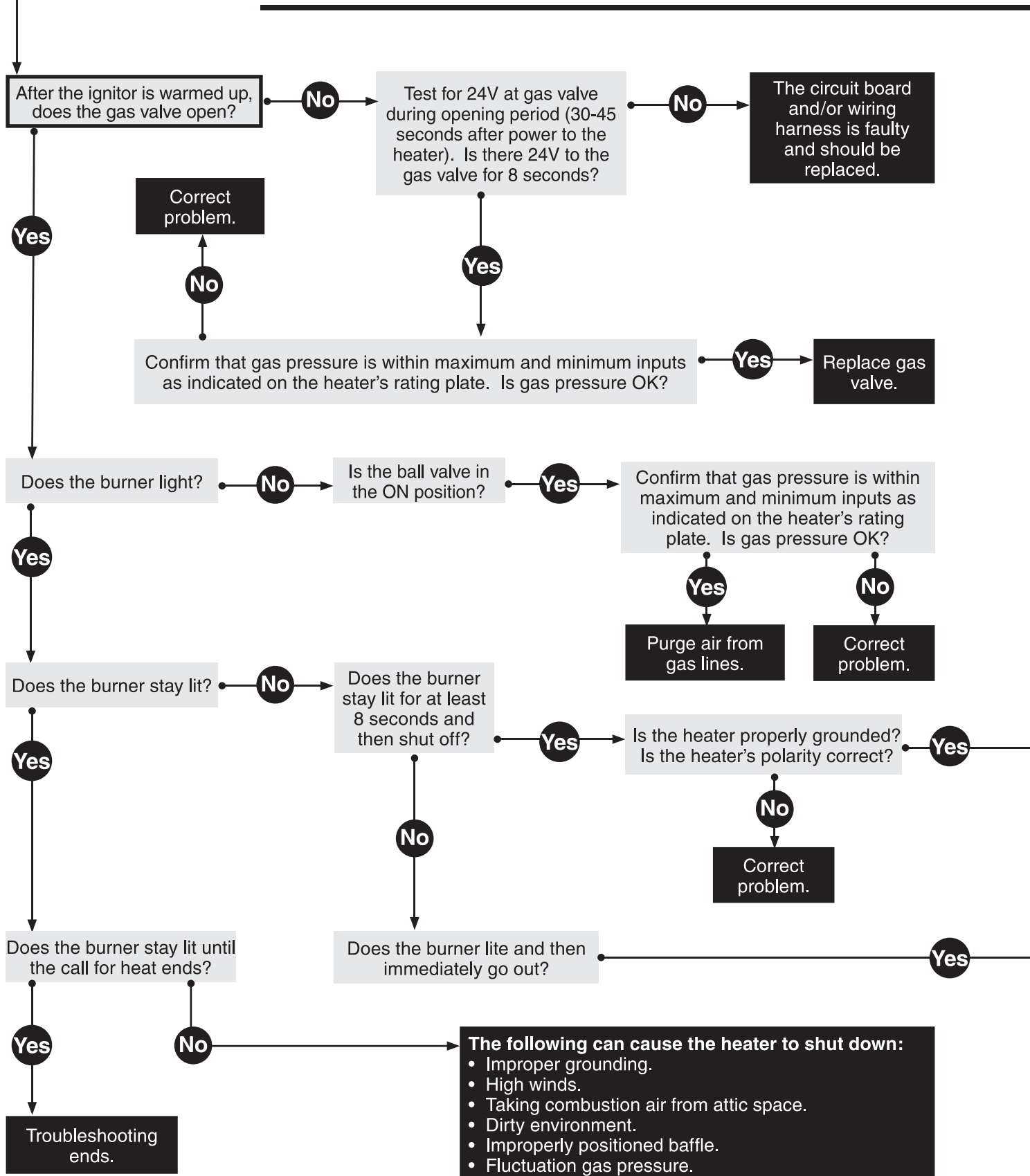



**NOTICE**

Bypassing any switch is intended for testing purposes only. Do not leave switch bypassed during normal operation or the heater's built-in safety mechanisms will be compromised.

**If the heater does not enter High Fire mode, check the following:**

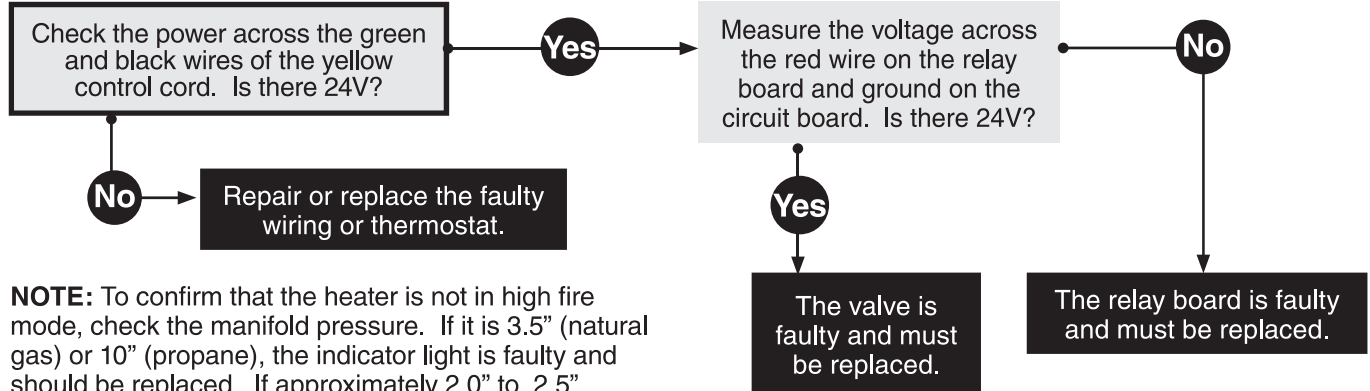

**NOTE:** To confirm that the heater is not in high fire mode, check the manifold pressure. If it is 3.5" (natural gas) or 10" (propane), the indicator light is faulty and should be replaced. If approximately 2.0" to 2.5" (natural gas) or 5.0" to 6.5" (propane), the heater is in low fire mode and the troubleshooting steps described here should be followed.

Sensing rod is faulty or the flame is too weak. Confirm that the heater is operating at the proper gas pressure as indicated on the heater's rating plate. Replace the sensing rod if necessary.

No

With a micrometer, check DC voltage at the flame rod. Is it greater than 0.7 microamps?

Yes

Confirm that the flame rod sensor wire is okay; if so, replace the circuit board.

Confirm that gas pressure is within maximum and minimum inputs as indicated on the heater's rating plate. Is gas pressure OK?

Yes

Either there is a restriction in the exhaust or the pressure switch is faulty.

No

Correct problem.

# 5.0 Parts

Figure 5.1 • Burner Assembly Components

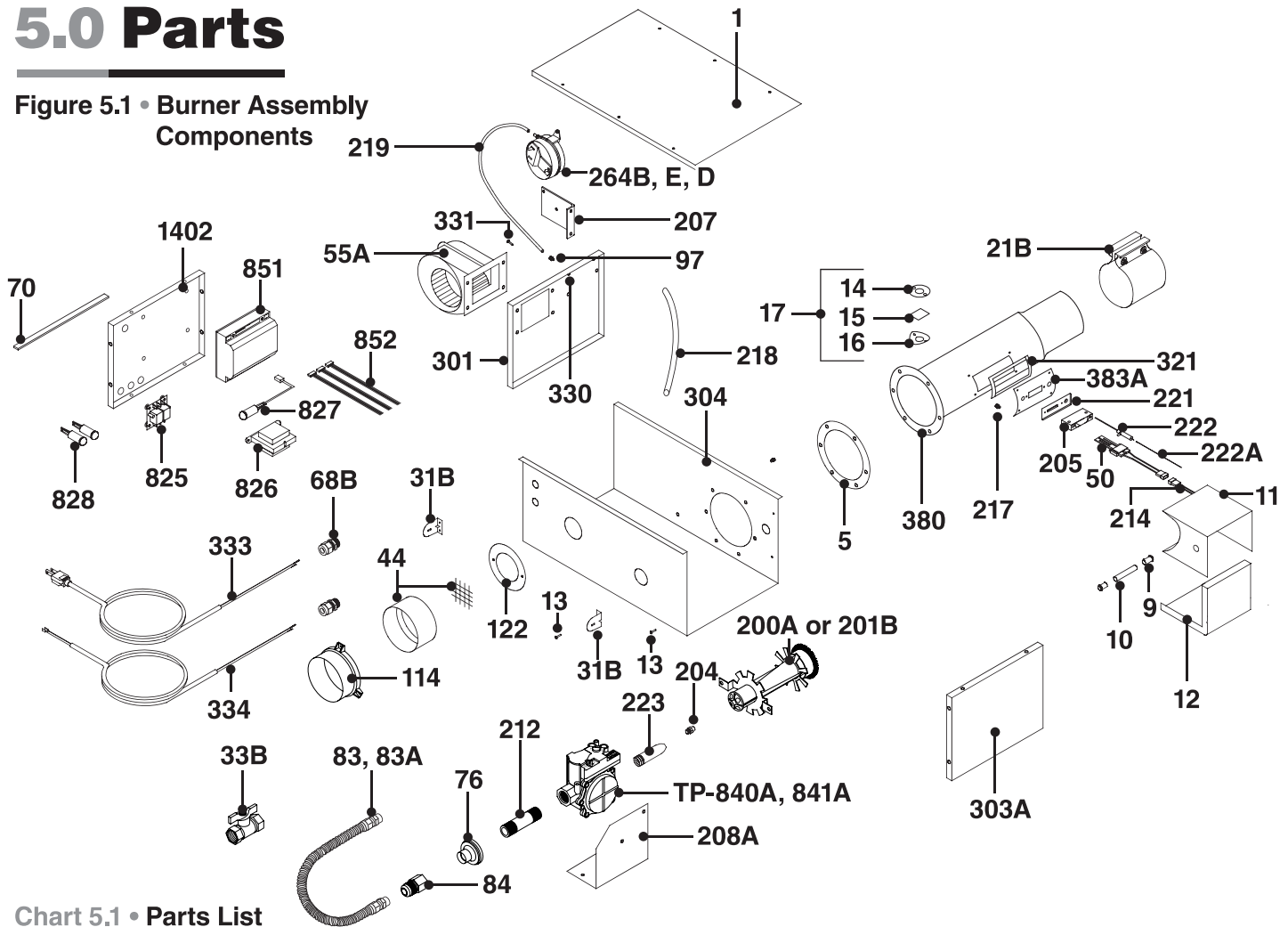
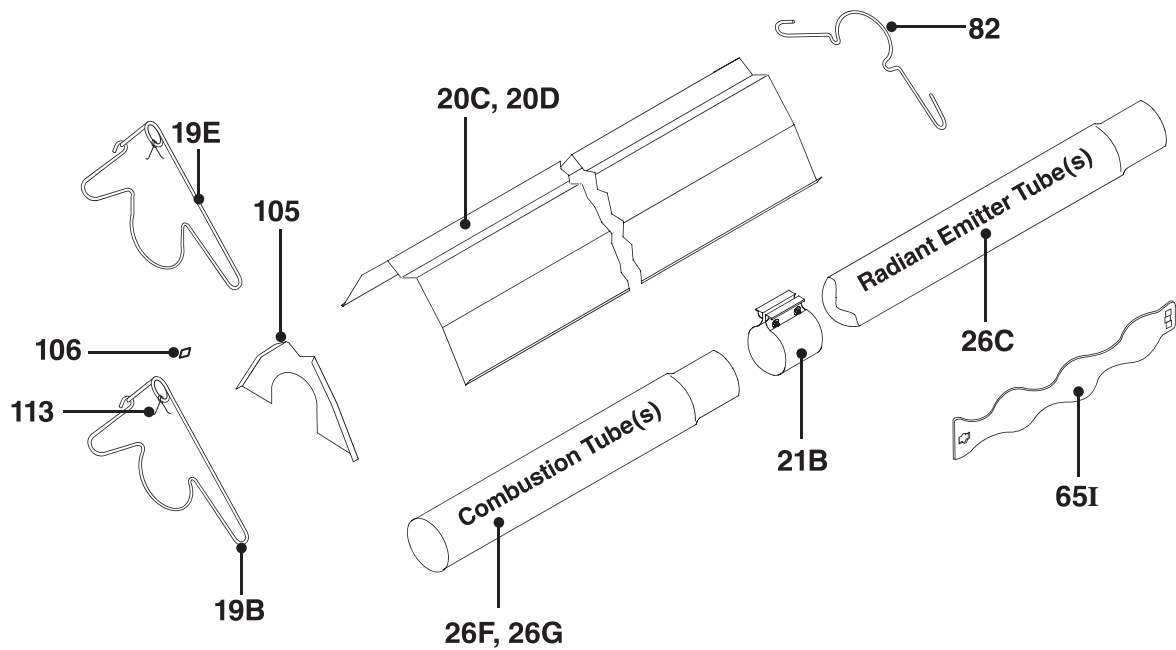

Chart 5.1 • Parts List

Part No.	Description	Part No.	Description
TP-1	Control Box Cover	TP-31B	Control Box Mounting Bracket
TP-5	Flange Gasket	TP-33B	1/2" Shut-Off Ball Valve / Inlet Tap
TP-9	Conduit Coupling	TP-44	Metal Air Orifice with Screen (consult factory)
TP-10	Conduit 4" x 1/2"	TP-50	Glo-Bar Ignitor
TP-11	Glo-Bar Ignitor Box	TP-55A	Fan Blower
TP-12	Glo-Bar Ignitor Box Cover	TP-65I	36" Interlocking Turbulator Baffle
TP-13	8 x 1/2" Self-Drilling Screw	TP-68B	Large Strain Relief Bushing with Lock Nut
TP-14	Sight Glass Gasket	TP-70	Control Box Cover Gasket (per foot**)
TP-15	Sight Glass	TP-76	Rubber Grommet
TP-16	Sight Glass Washer	TP-82	Reflector Center Support (RCS)
TP-17	Sight Glass Kit	TP-83	24" Stainless Steel Flexible Gas Connector
TP-19B	4" Wire Hanger with Tension Spring	TP-83A	24" PVC Coated S.S. Flexible Gas Connector*
TP-19E	Optional 4" Elongated Wire Hanger	TP-84	1/2" Female / Male Flare Fitting
TP-20C	120" Aluminum Reflector	TP-97	1/4" x 1/4" Brass Int./Ext. Atmos. Barb Fitting
TP-20D	120" Stainless Steel Reflector*	TP-105	Aluminum Reflector End Cap
TP-21B	4" Standard Tube Clamp	TP-106	Reflector End Cap Clips (8 pcs.)
TP-26F	10 ft. Uncoated (ALUM) Combustion Tube	TP-113	Reflector Tension Spring
TP-26G	10 ft. Uncoated (AL-TI) Combustion Tube	TP-114	Plastic Air Orifice with Screen
TP-26C	10 ft. Hot Rolled Steel (HRT) Radiant Tube	TP-122	Gasket for Air Orifice and Air Collar

\*May be used with stainless steel upgrades. \*\* 6 feet total required to cover outer edges of the burner control box.

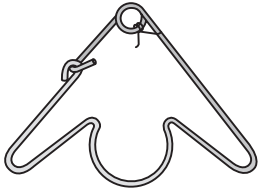
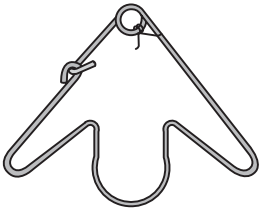
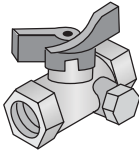

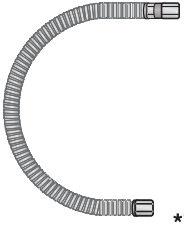
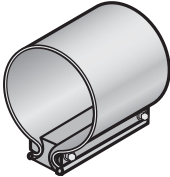

Figure 5.2 • Tube & Reflector Components



Part No.	Description	Part No.	Description
TP-200A	Burner (65-100 MBH Models)	TP-303A	End Panel, Right
TP-201B	Burner (125-150 MBH Models)	TP-304	Burner Control Box Outer Shell
TP-204	Gas Orifice (consult factory)	TP-321	Ignition Plate Gasket
TP-205	Glo-Bar Holder	TP-330	Divider Grommet
TP-207	Pressure Switch Mounting Bracket	TP-331	Green Self Tap Ground Screw
TP-208A	Gas Valve Mounting Bracket	TP-333	36" Black 120 Volt Plug
TP-212	1/2" x 3" Pipe Nipple	TP-334	36" Yellow 24 Volt Control Wire
TP-214	Glo-Bar Wiring Harness	TP-380	16" Burner Tube with Flange
TP-217	Pressure Switch Barb	TP-383A	Glo-Bar Ignitor Plate
TP-218	Differential Switch Vinyl Sensing Tube (exhaust)	TP-825	HLRB Relay Board
TP-219	Differential Vinyl Sensing Tube (burner)	TP-826	40VA Transformer
TP-221	Glo-Bar Holder Gasket	TP-827	Red LED Display Diagnostic Light
TP-222	Flame Rod	TP-828	Amber Operational Indicator Light
TP-222A	Flame Rod Wire	TP-840A	36G54-224 Gas Valve - Natural Gas Assembly
TP-223	Gas Manifold	TP-841A	36G54-226 Gas Valve - LP Gas Assembly
TP-264B	Differential Pressure Switch, 65 to 75 MBH	TP-851	Micro 60U-24 Diagnostic Circuit Board
TP-264E	Differential Pressure Switch, 100 & 125 MBH	TP-852	3-Piece Wire Harness Set for Micro 60 Board
TP-264D	Differential Pressure Switch, 150 MBH	TP-1402	End Panel, Left
TP-301	Center Divider Panel		

## Kit Contents Check List

Chart 5.2 • Kit Contents for AG2 Series - Reference the length column for your model.

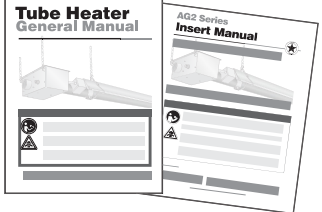
AG2 Series Kit Contents						
<p><b>TP-19B</b> 4" Hanger with Reflector Tension Spring</p>  <p><b>*TP-19C</b></p>	<p><b>TP-19E</b> Optional 4" Elongated Hanger with Reflector Tension Spring</p> 	<p><b>TP-33B</b> 1/2" Shut-Off Valve (Ball Valve &amp; Inlet Tap)</p> 	<p><b>TP-106</b> Reflector End Cap Clips</p> 	<p><b>TP-82</b> 4" Reflector Center Support (RCS)</p>  <p><b>*TP-829</b></p>		
<p><b>TP-83</b> 24" Stainless Steel Flexible Gas Connector</p>  <p><b>*TP-83A</b></p>	<p><b>TP-21B</b> 4" Tube Clamp</p>  <p><b>*TP-220</b></p>	<p><b>TP-105</b> Reflector End Cap</p>  <p><b>*TP-105A</b></p>	<p>Tube Heater General and AG2 Series Insert Manuals F/N: LIOGTa &amp; LIOAG2a</p> 			
Part No.	Description	20 Ft.	30 ft.	40 ft.	50 ft.	60 ft.
TP-19B	4" Hanger w/ Tension Spring	3	4	5	6	7
TP-19E	4" Elongated Hanger w/ Tension Spring	Optional	Optional	Optional	Optional	Optional
TP-21B	4" Tube Clamp	2	3	4	5	6
TP-33B	1/2" Shut-Off Valve & Inlet Tap	1	1	1	1	1
TP-82	4" Reflector Center Support	1	1	1	1	1
TP-83	24" S.S. Flexible Gas Connector	1	1	1	1	1
TP-105	Reflector End Cap	2	2	2	2	2
TP-106	Reflector End Cap Clips	8	8	8	8	8
LIOGTa	General Tube Heater Manual	1	1	1	1	1
LIOAG2a	AG2 Series Insert Manual	1	1	1	1	1

Filled By: \_\_\_\_\_

\* Part number for models upgraded with stainless steel options.

### Approvals

- CSA.
- Indoor/outdoor approval.
- Commercial/agricultural approval.

### Limited Warranty

- 1 year - Burner box components.
- 3 years - Combustion and radiant tubes.
- 5 years - Stainless steel burner.
- See page 36 of the General Tube Heater Manual for terms and conditions.



© 2007 Detroit Radiant Products Co.  
21400 Hoover Road • Warren, MI 48089  
Phone: (586) 756-0950 Fax: (586) 756-2626  
www.detroitradiant.com • sales@drp-co.com